

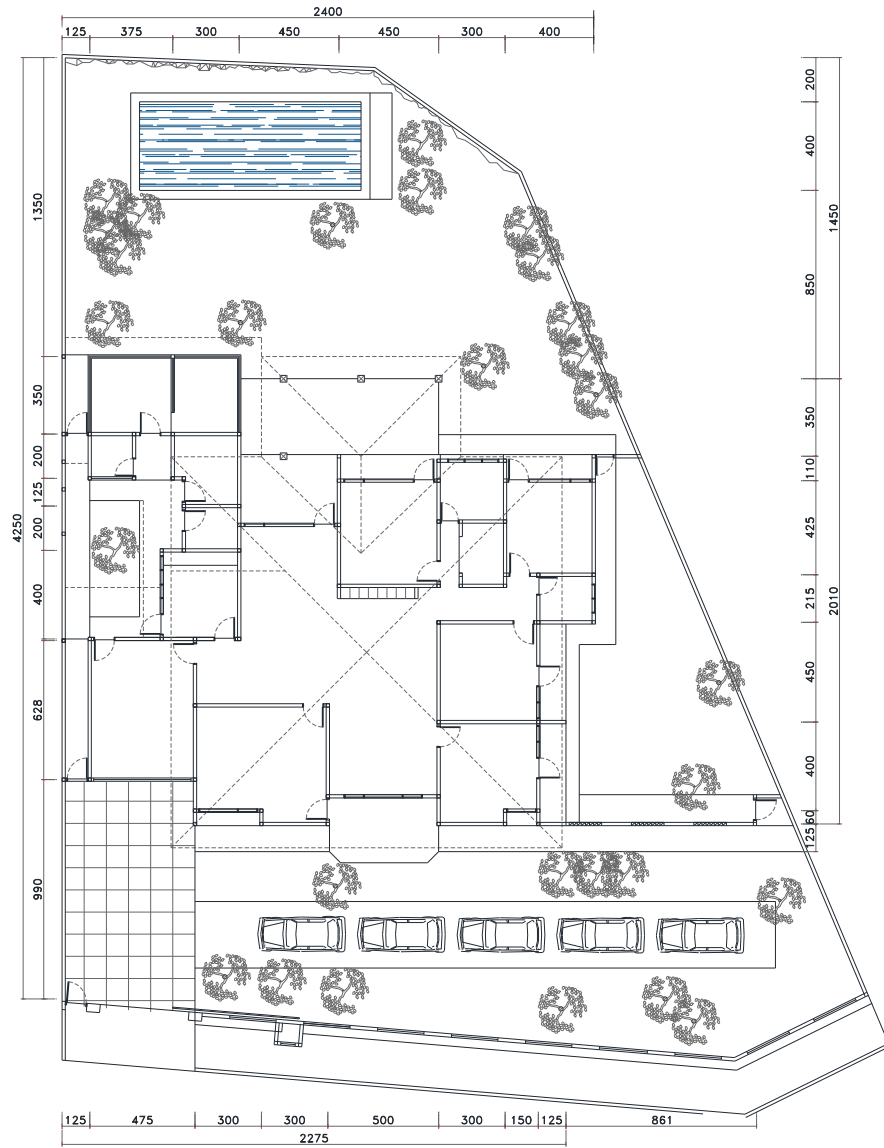

DESIGN DEVELOPMENT
THE SAMDHANA INSTITUTE
OFFICE

TAMPOMAS - 33 BOGOR



DENAH EKSTING

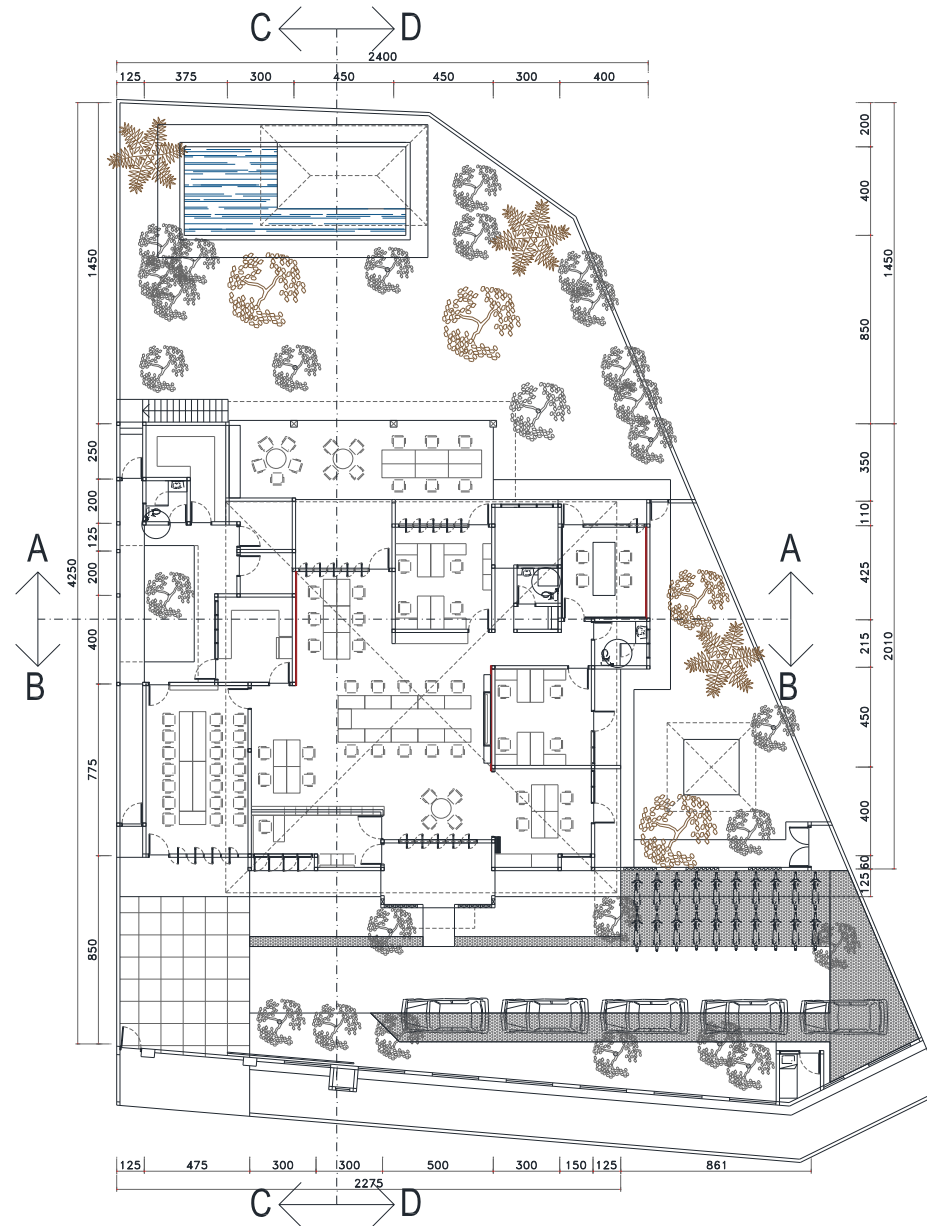

DENAH DESIGN LANTAI 1



RUANG KERJA BERSAMA 3D

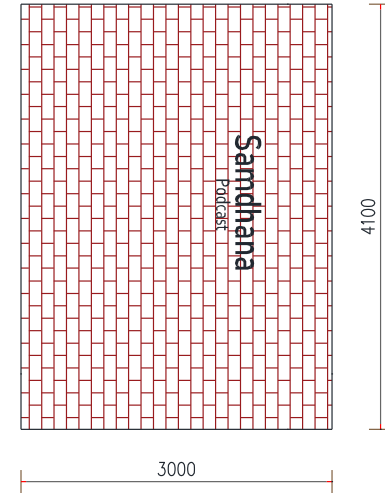
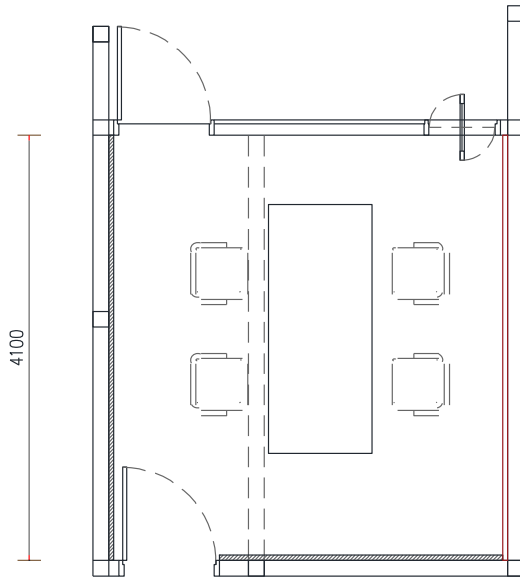
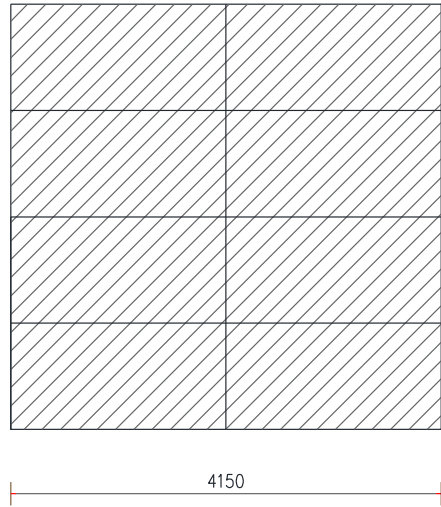

RUANG PODCAST

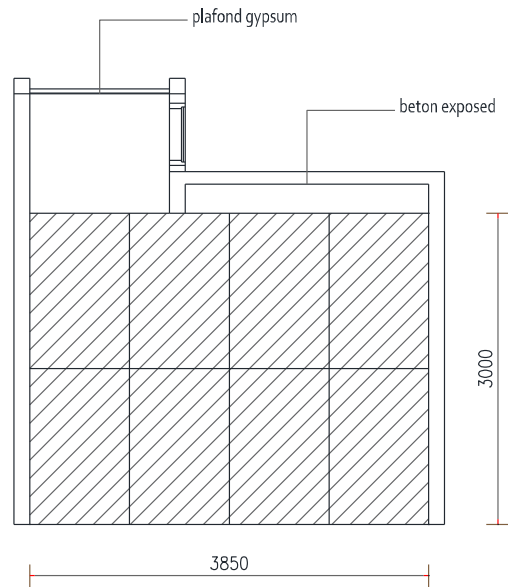



RUANG PODCAST

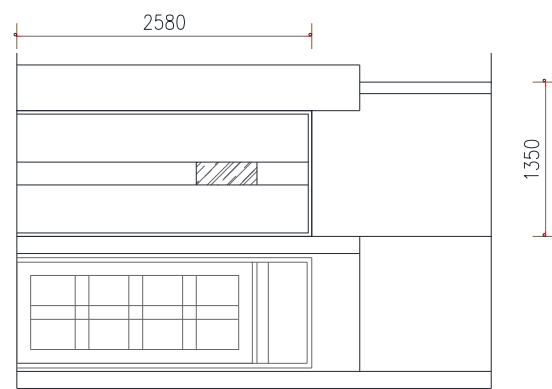
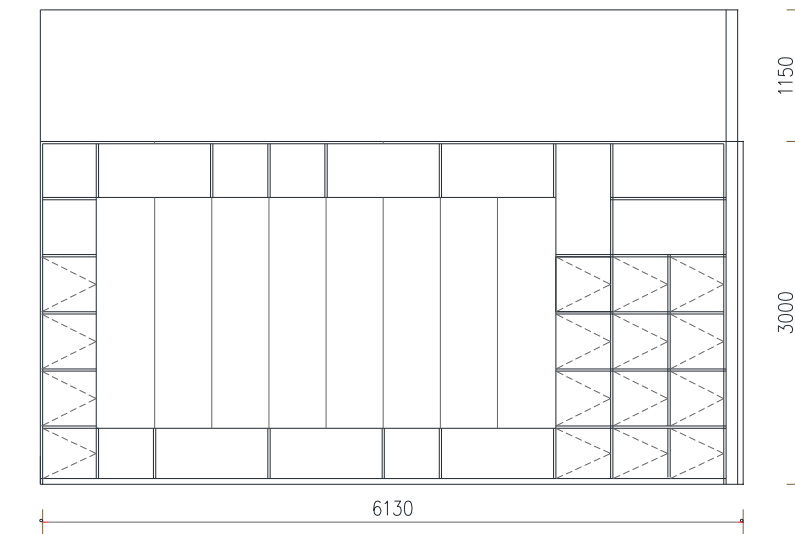
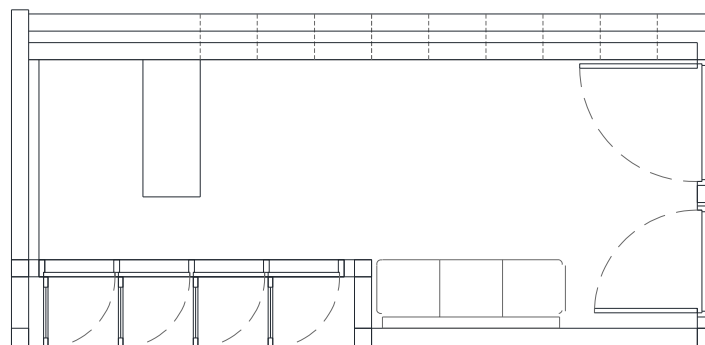
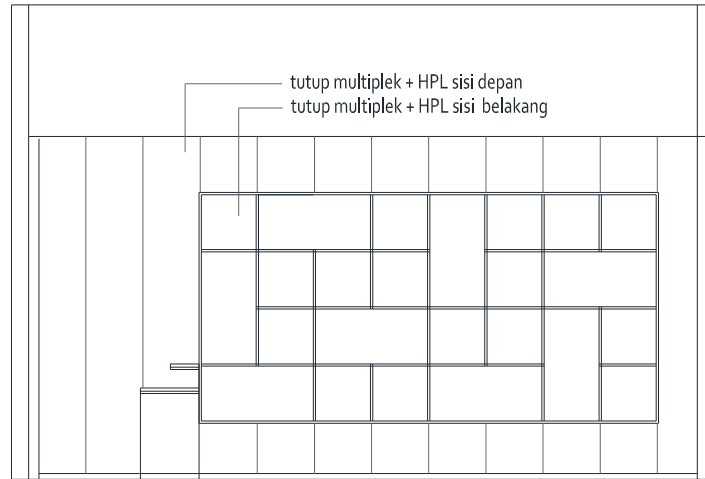
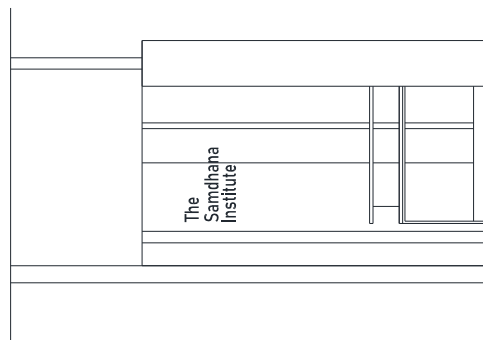

RUANG TUNGGU



RUANG TUNGGU

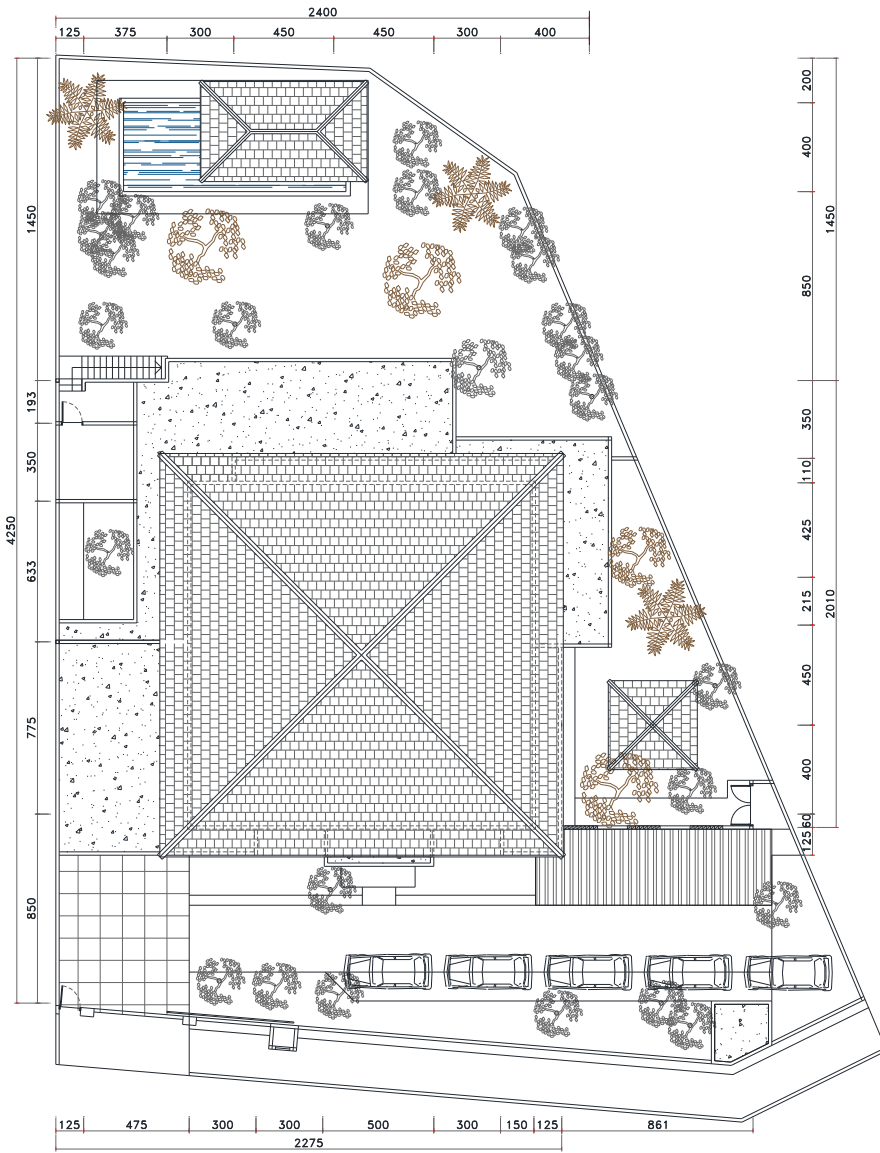

DENAH LANTAI 2 DESIGN

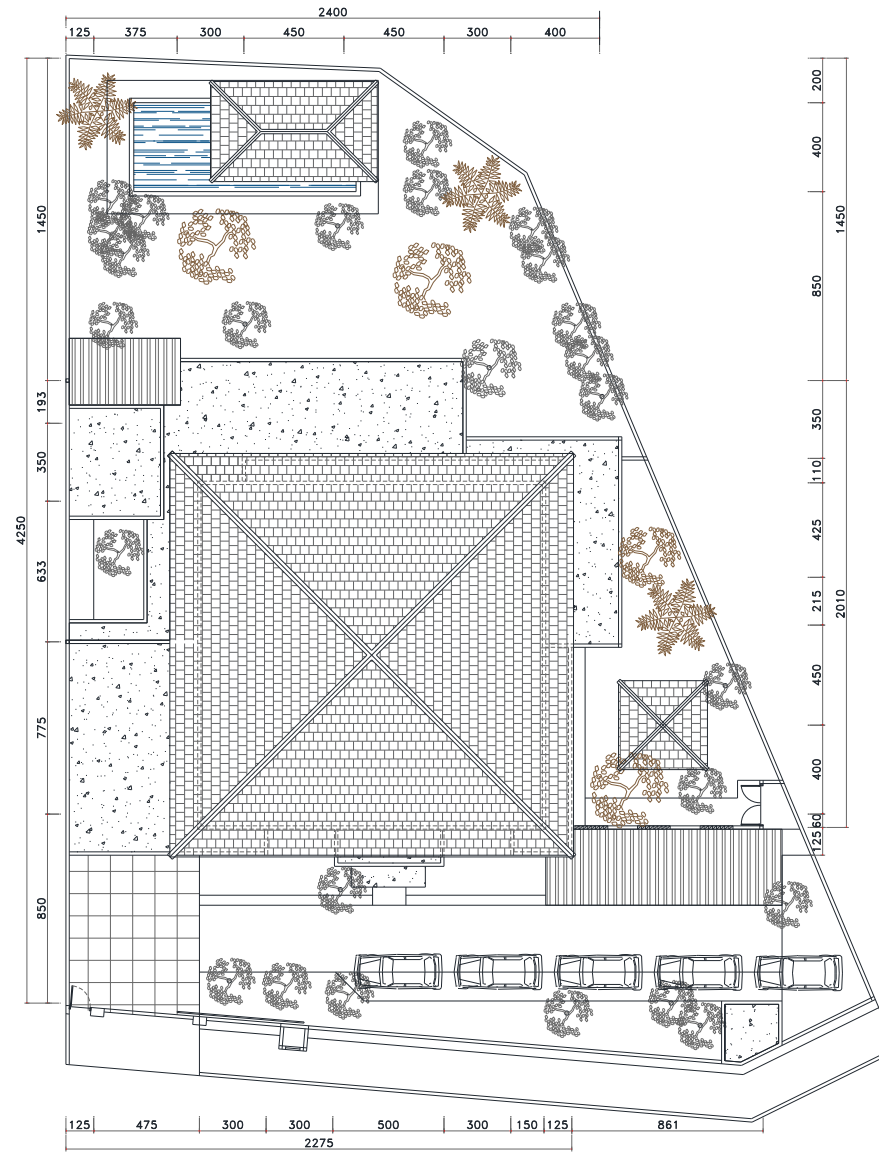

DENAH ATAP DESIGN

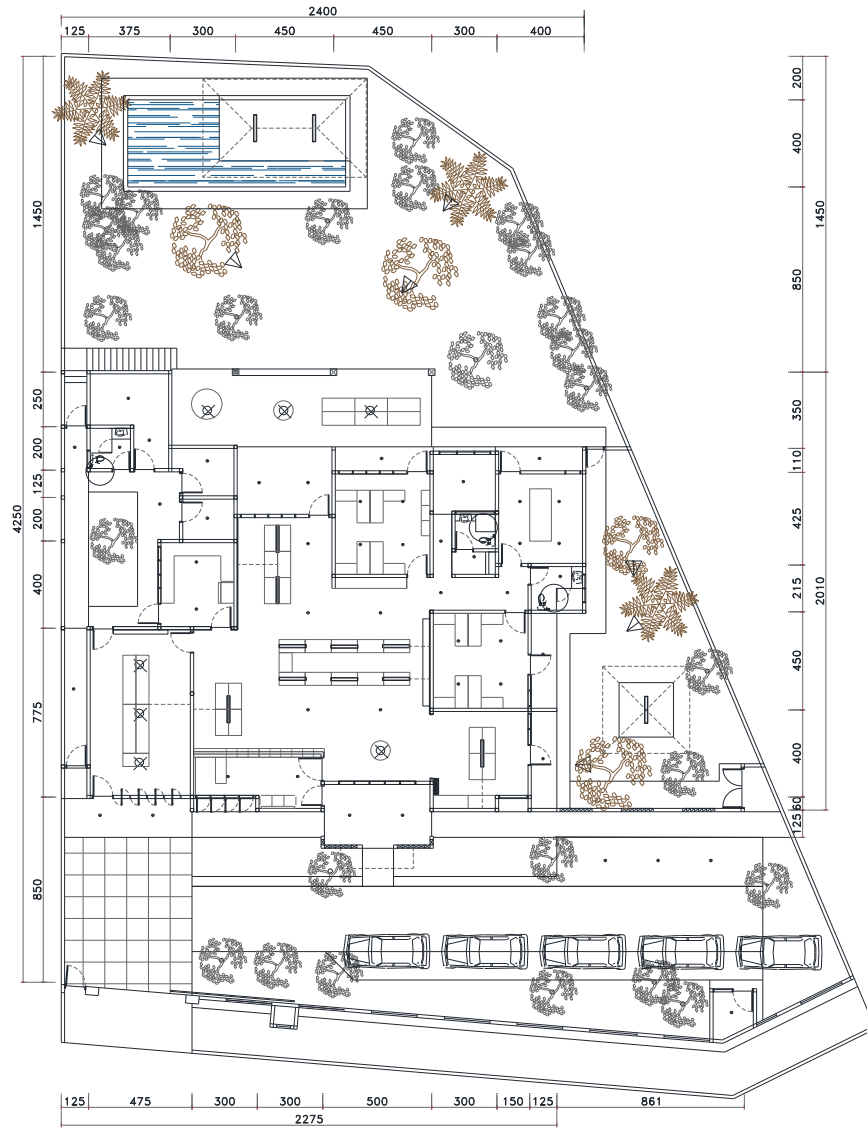

DENAH LAMPU LANTAI 1

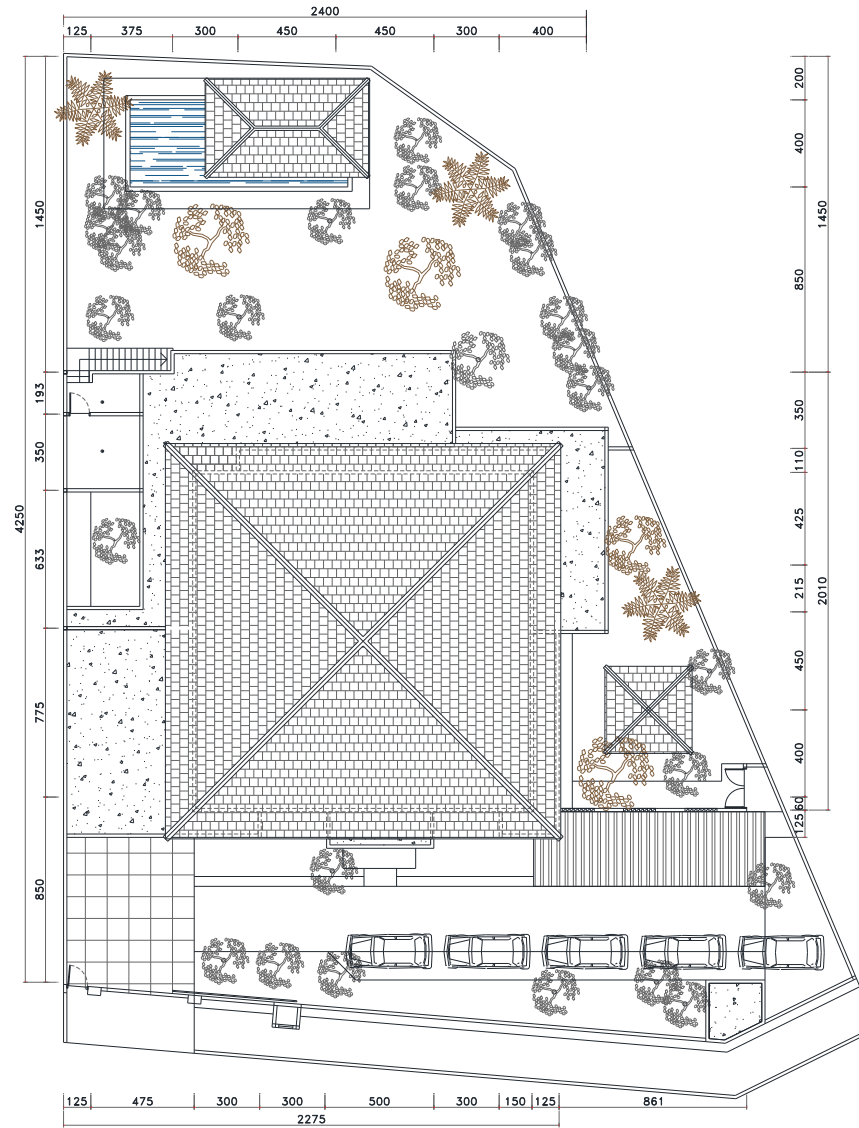

DENAH LAMPU LANTAI 2



LAMPU GANTUNG BOX



LAMPU GANTUNG BULAT



LAMPU FLAT GENERAL



LAMPU SPOT POHON



DENAH INSTALASI BUANGAN AIR HUJAN UNTUK RESERVOIR



TAMPAK DEPAN EKSTING

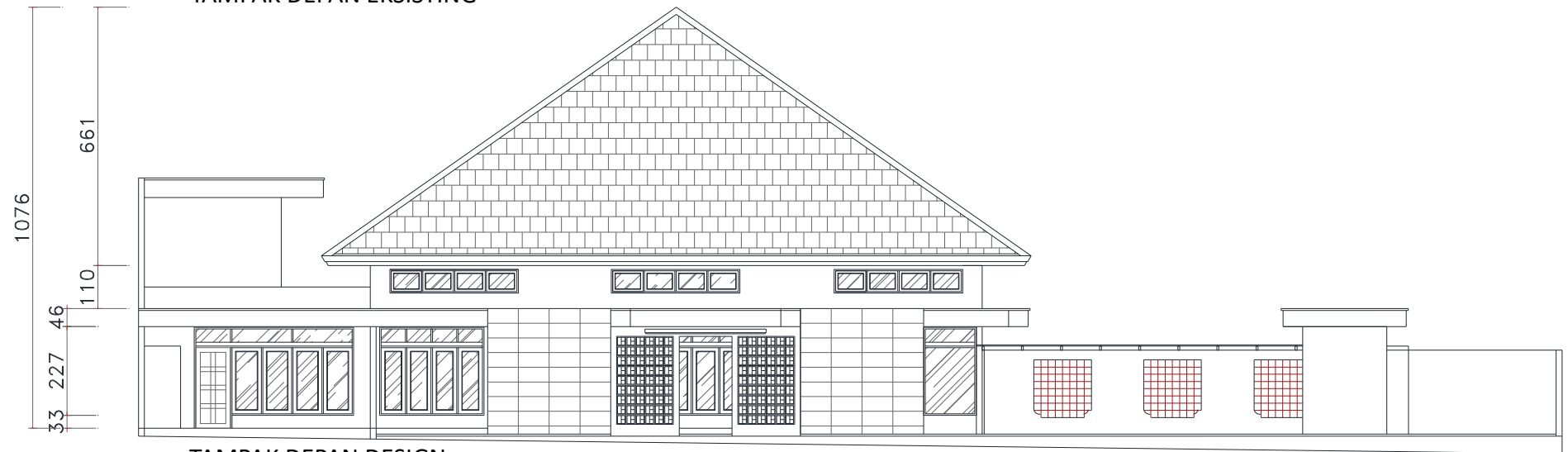

TAMPAK DEPAN DESIGN



TAMPAK DEPAN DESIGN



TAMPAK SAMPING TAMAN EKSSISTING



TAMPAK SAMPING TAMAN DESIGN



IMAGE TAMAN SAMPING - BELAKANG



PAGAR KAMPROT+TANAMAN RAMBAT





TAMPAK SAMPING DAPUR EKSTING

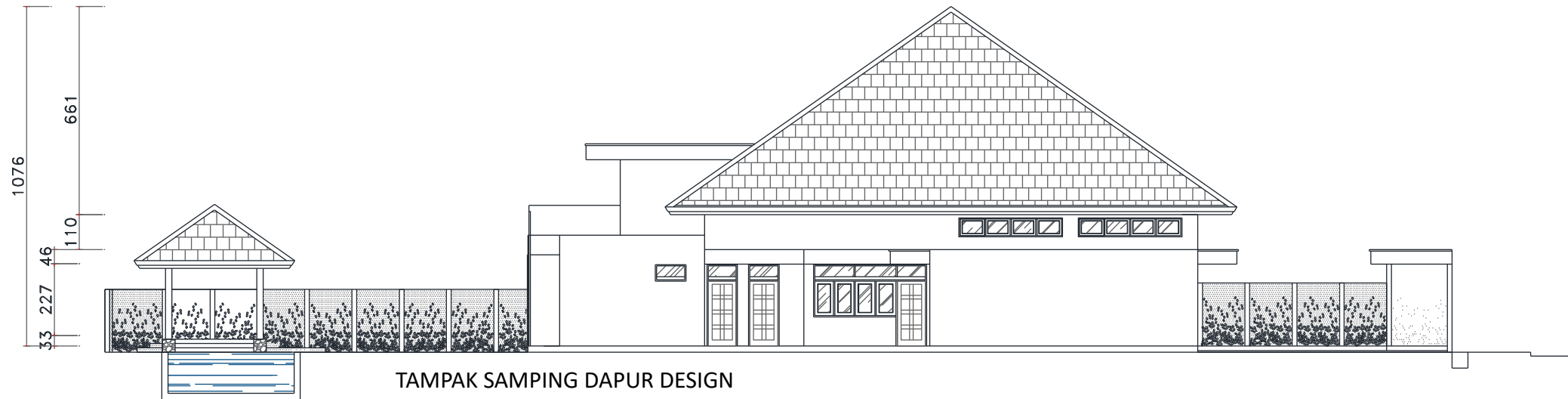

TAMPAK SAMPING DAPUR DESIGN

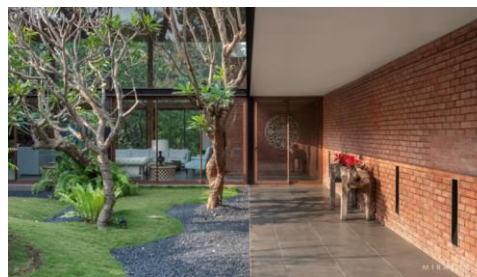

IMAGE TAMAN SAMPING-BELAKANG



PAGAR KAMPROT+TANAMAN RAMBAT



TAMPAK BELAKANG EKSISTING



TAMPAK BELAKANG DESIGN

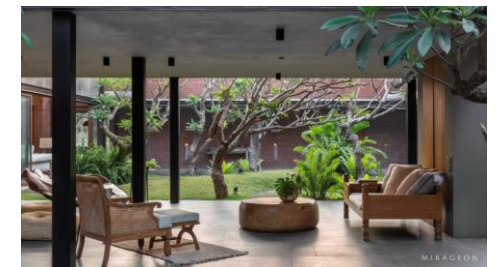

IMAGE VIEW DARI TERAS BELAKANG



TAMPAK BELAKANG DESIGN



POTONGAN A-A

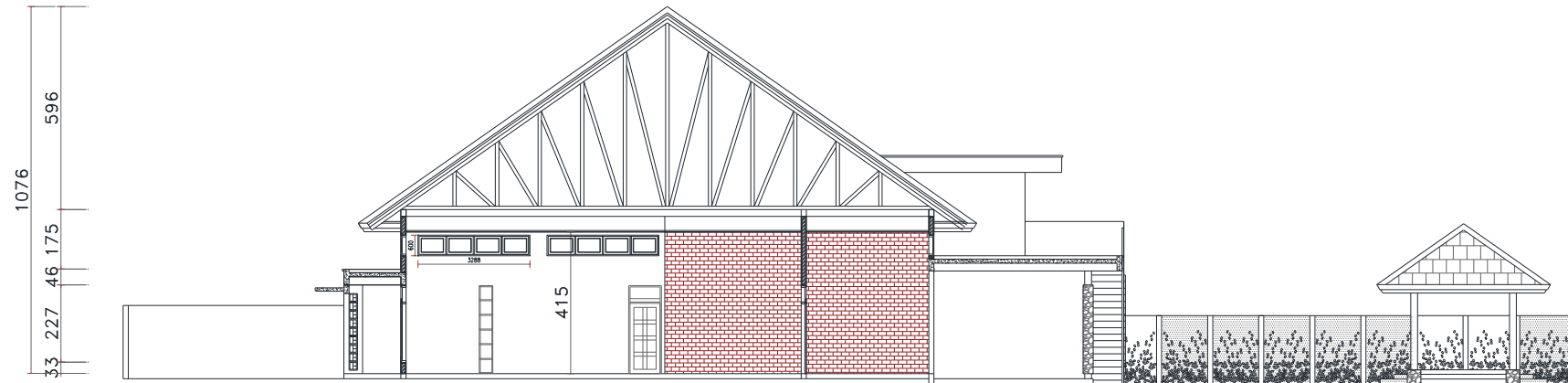

POTONGAN C-C

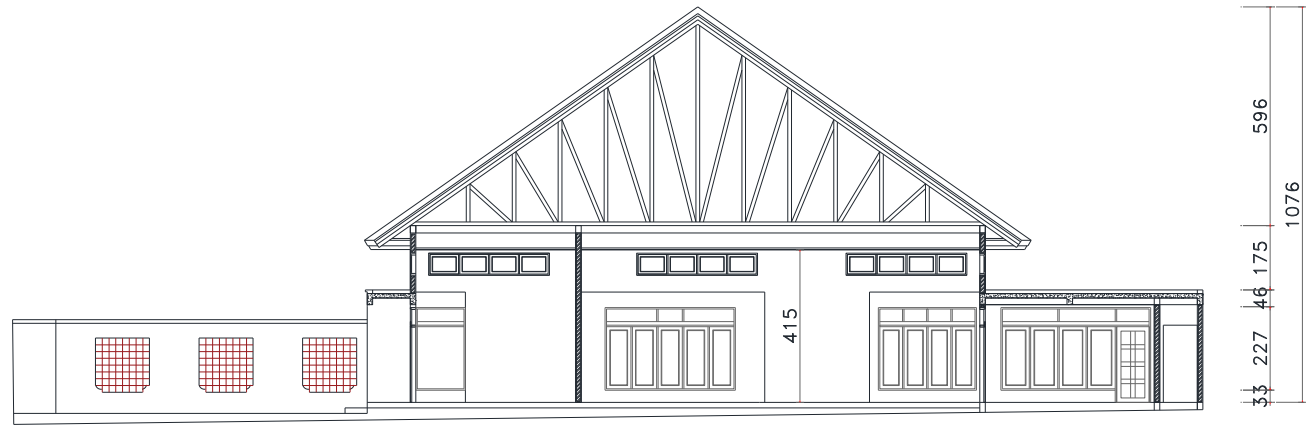

POTONGAN B-B

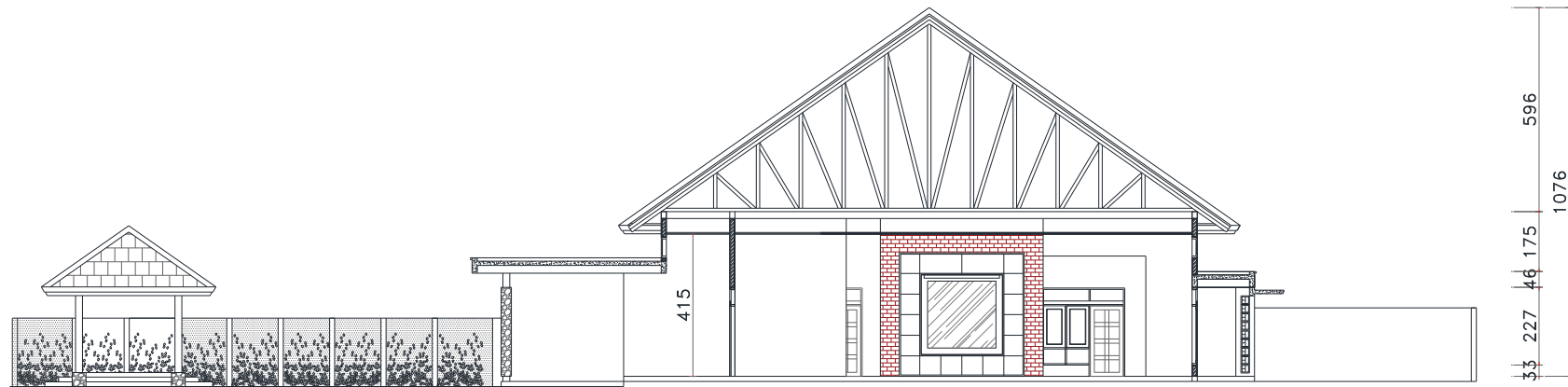

POTONGAN D-D

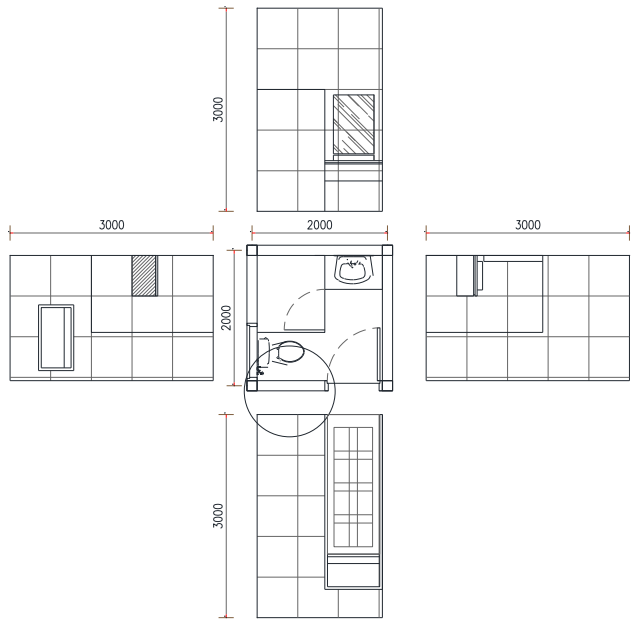

Toilet Umum depan Dapur

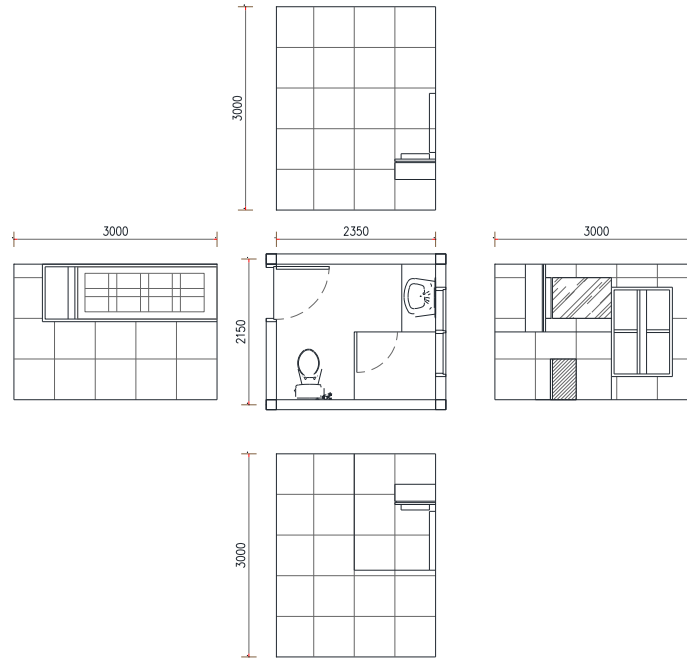

Toilet Karyawan sisi Taman samping

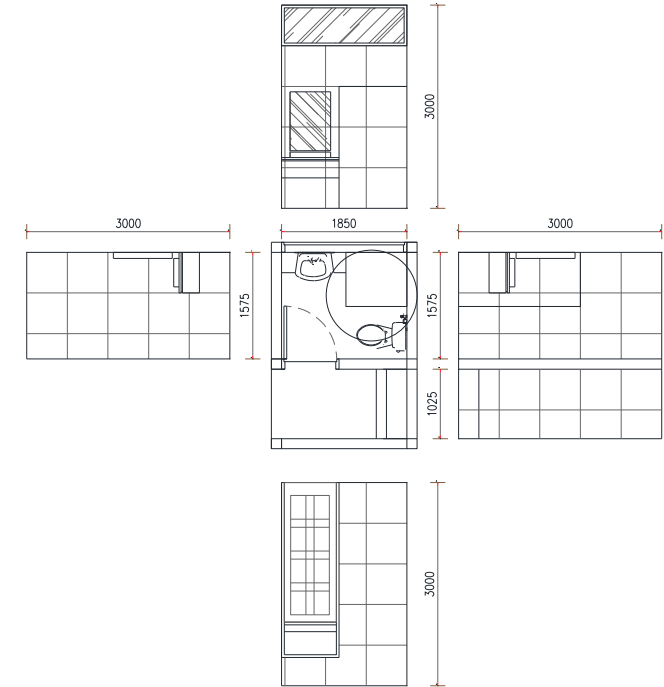

Toilet Karyawan sisi Musholla

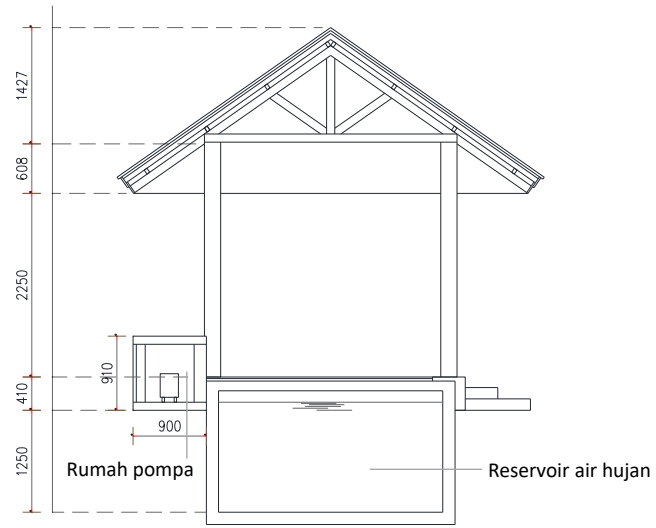

POTONGAN

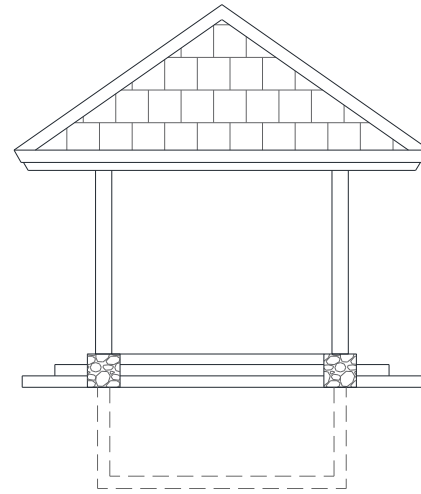

TAMPAK DEPAN

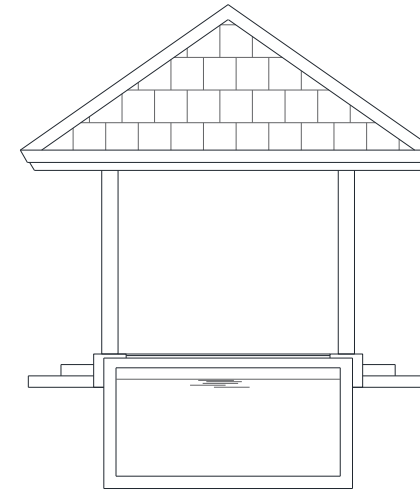

TAMPAK POTONGAN

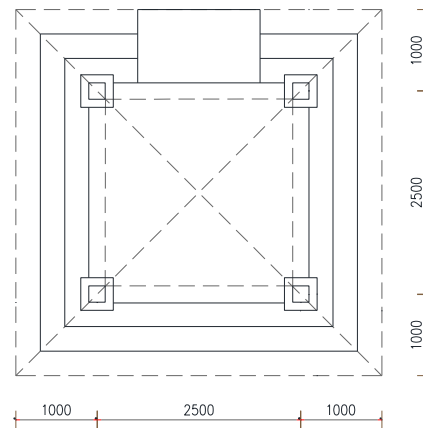

DENAH

GAZEBO TAMAN SAMPING

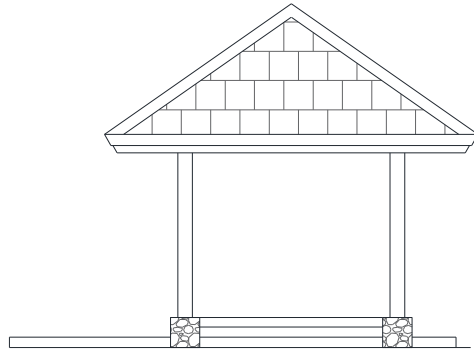

TAMPAK SAMPING

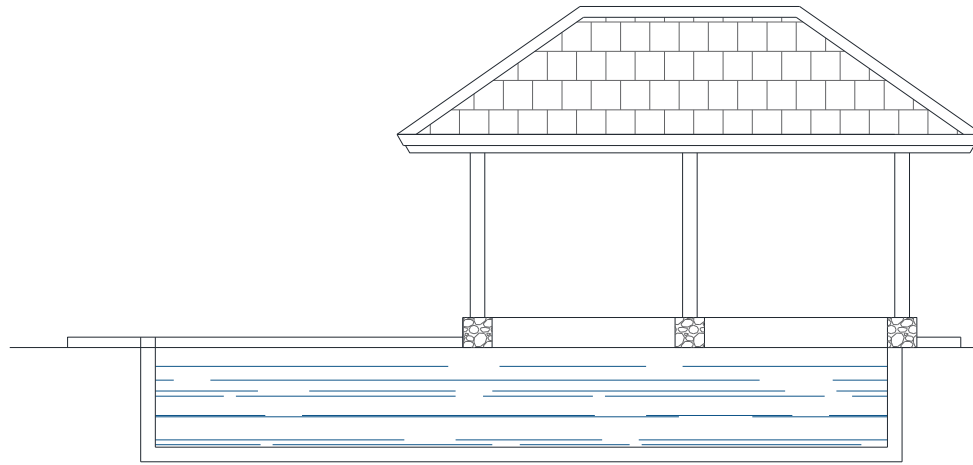

TAMPAK DEPAN

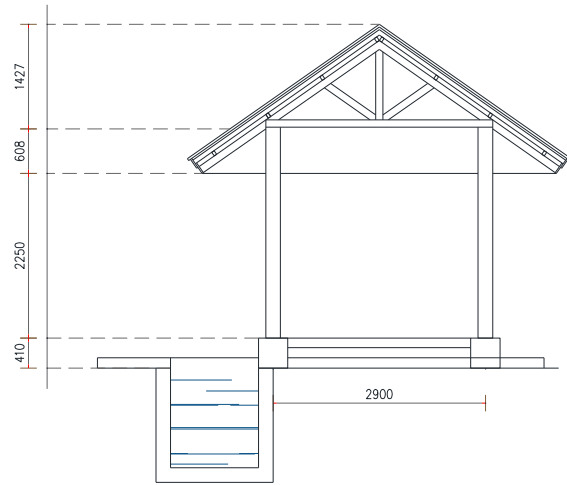

POTONGAN

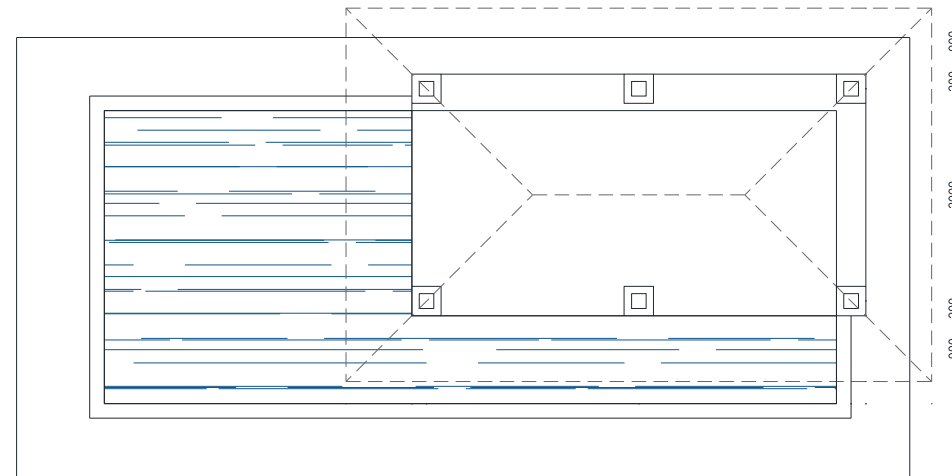

DENAH

GAZEBO TAMAN BELAKANG

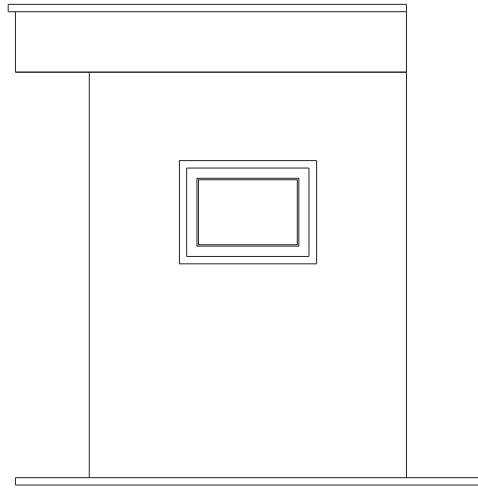

TAMPAK SAMPING

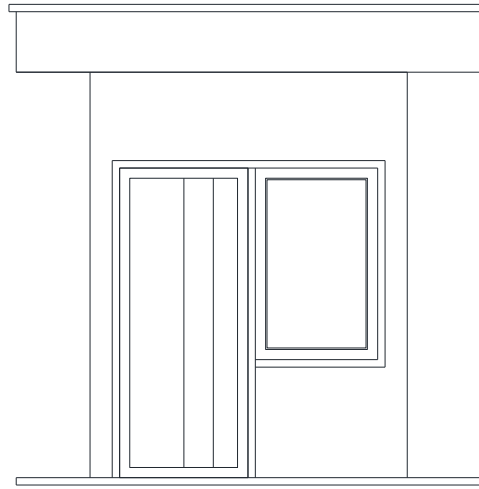

TAMPAK DEPAN

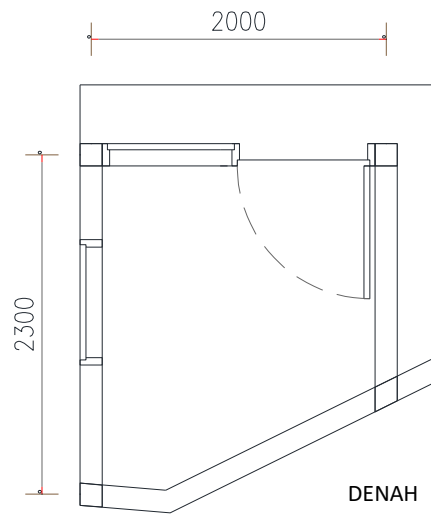
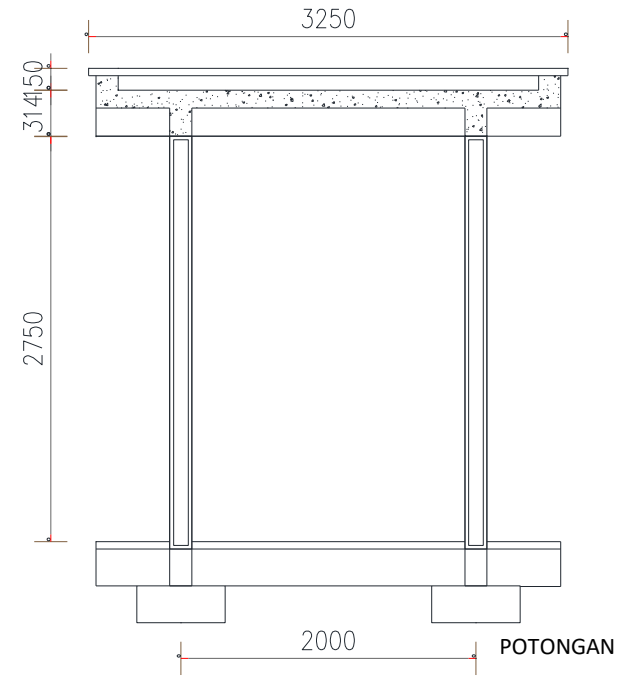

DENAH

POS JAGA